

8" - 2 PC. CAST BASE COVERS

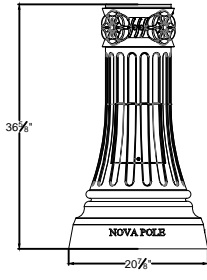

9142
TALLAHASSEE
2PC BASE COVER

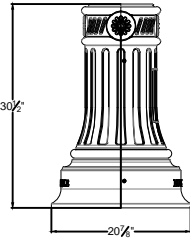

9158
GIVERNY
2 PC. BASE COVER

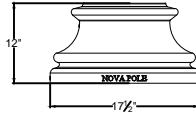

9150
HENDERSON TYPE 8
2 PC BASE COVER

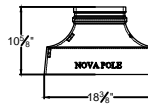

9152
ALDER
2 PC BASE COVER

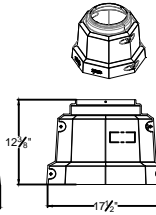

9147
FRASER TYPE 8
2PCBASE COVER

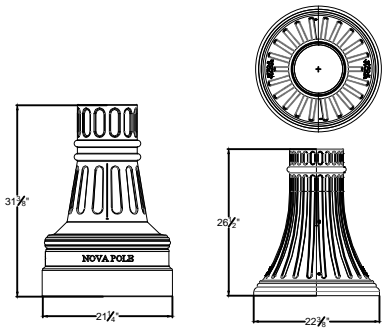

GLENORA
2 PC BASE COVER

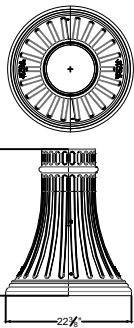

9160
OKANAGAN
2 PCBASE COVER

STRUCTURAL BASE CASTING

GASTOWN CAST BASE

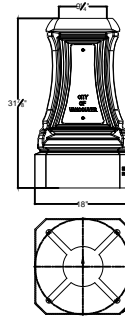

18" BCD

8" CAST BASE PLATES

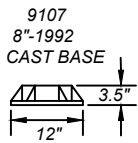

9107
8"-1992
CAST BASE
11"-12" B.C.D.
1' -1 1/4" AB
9113 NUT CVRS

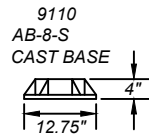

9110
AB-8-S
CAST BASE
11"-14" B.C.D.
1' -1 1/4" AB
9114 NUT CVRS

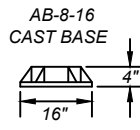

AB-8-16
CAST BASE
14 3/4"-16 3/4" B.C.D.
1' -1 1/4" AB
9114 NUT CVRS

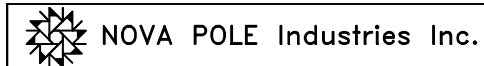

SIZE	DATE: - 29/01/2015	DWG NO. APPROVAL	REV
	SO NO. -	SHEET 1 OF 1	

BIN INFORMATION SHEET

DESCRIPTION	REVISION	MADE	CHKD	SUBD	APPROVED	INSP	DATE

SCALE NTS	11	CUSTOMER DWG NO. -
--------------	----	-----------------------

THIS DRAWING IS THE PROPERTY OF NOVA POLE INDUSTRIES INC. AND CONTAINS CONFIDENTIAL INFORMATION. REPRODUCTION OF THIS DRAWING IN FULL OR PART OR DISCLOSURE OF ANY INFORMATION FROM IT WITHOUT EXPRESS WRITTEN PERMISSION OF NOVA POLE INDUSTRIES INC. IS NOT PERMITTED.